

INSTRUCTION MANUAL

PNEUMATIC CHAMFERING TOOL

Please read this manual carefully before you attempt to use your tool so that you may use it properly and safely.

CIRCUIT BEVELER Model CB-02 **PROFESSIONAL TOOL**



Specifications

Model	CB-02
Maximum Operating Pressure	0.6 MPa
Air Consumption (No Load)	0.4 m ³ /min
Rated Speed (No load)	13,000 min ⁻¹
Chamfer Angle	45°
Mass (Weight)	1.8 kg
Sound Pressure Level	85 dB(A)
Sound Power Level	96 dB(A)
Vibration Level	3.8 m/s ²
Thread Size of Air Inlet	Rc1/4

Due to continuous product development/improvement the specifications and configurations in this document are subject to change without prior notice.



Manufactured by :
NITTO KOHKI Co., Ltd.
2-9-4, Nakaikegami, Ohta-ku,
Tokyo, 146-8555, Japan
TEL : (81)-3-3755-1111
FAX : (81)-3-3753-8791
E-mail : overseas@nitto-kohki.co.jp
URL : www.nitto-kohki.co.jp

Keep the manual handy – so you can use it whenever necessary.

Original Instructions

Thank you very much for your purchase of this **Nitto Kohki products.**







Before using your tool, please read this manual carefully so that you may use it properly to get the most out of it.

Please keep the manual handy - so you can use it whenever necessary.



- **English** : Please ask your dealer or distributor for instruction manual in local language(s).
- **German** : Bitte fragen Sie Ihren Händler nach eine Betriebsanleitung in Landessprache.
- **French** : S'il vous plait, veuillez demandez à votre fournisseur de manuel instruction en langue locale.
- **Spanish** : Por favor, contacte con su distribuidor para el manual de instrucciones en español.
- **Portuguese** : Por favor pessa ao seu agente ou distribuidor o manual de instruções em linguagem local.
- **Italian** : Per Manuale Istruzioni in lingua locale Vi preghiamo di rivolgerci al rivenditore o distributore.
- **Dutch** : Vraag uw handelaar om een nederladstalige gebruiksaanwijzing.
- **Swedish** : Be er lokala Åtreförsäljare eller distributör om manualer på svenska.
- **Danish** : Venligst henvend Dem til den danske distributør for instructions manualer.
- **Polish** : Proszę pytać swojego dealera lub dystrybutora o instrukcje obsługi w języku localnym.
- **中文** : 請向當地供應商或經銷商詢問中文使用說明書

CONTENTS	page
IMPORTANT SAFETY INSTRUCTIONS	2
GENERAL: TOOLS	2
GENERAL: PNEUMATIC TOOLS	3
INSTRUCTIONS FOR THIS TOOL	4
1. USAGE	4
2. CHECK THE CONTENTS OF THE PACKAGE	4
3. AIR SUPPLY	4
4. HOW TO OPERATE THE TOOL	4
5. HOW TO REPLACE INDEXABLE INSERT.....	6
6. CONDITION FOR USE	6
7. THREAD SIZE OF HOSE FITTING	6
8. STORAGE.....	6
9. ORDERING SERVICE PARTS	7
10. OPTIONAL PARTS	7
11. EXPLODED DIAGRAM : CB-02	8

PICTOGRAM

-  Warning: It might be dangerous to operate the tool if the instructions supplied are not followed.
-  Using this tool improperly could result in serious injury. Read the instruction manual before use.
-  Always wear suitable eye protection.
-  Always wear suitable hearing protection.
-  Always wear respiratory protective equipment (PPE).
-  Always wear protective gloves for protection of hands from vibration and shock.

The following Safety notations are used throughout the manual to highlight safety precautions for the user and for the tool.

	WARNING:	Indicates a potentially hazardous situation which, if not avoided by following the instructions given, could result in death or serious injury.
	CAUTION:	Indicates a potentially hazardous situation which, if not avoided by following the instructions given, could result in injury or material damage.

Please note, however, that failure to observe safety precautions under the “ **Caution**” category could result in a serious occurrence depending on the situation: please observe all safety precautions in the manual.

Caution: Important precautions for tool setup, operation and maintenance.

IMPORTANT SAFETY INSTRUCTIONS

When using the tool, please observe the safety precautions below to prevent possible accident or injury.

GENERAL: TOOLS

WARNING

TO OPERATORS

- **Wear proper clothing for the type of work being done.**
Take care so that clothing, ties, hair, etc. will not become entangled with the moving parts. If items become entangled it will cause the operator to be pulled towards the tool and lead to possible cause of accident or injury.
- **Always wear suitable eye protection.**
Remember, regular glasses are not safety glasses. The lenses are only shock resistant, which will not give you sufficient eye protection you may need in your working environment.
- **Always wear suitable hearing protection.**
- **Wear respiratory protective equipment (PPE).**
Wear respiratory protective equipment (PPE) when working in an environment where dust particles are generated in operation.
- **Always wear suitable protective gloves.**
- **Avoid working posture that is too stressful.**
Always ensure a firm footing and well balanced posture.
- **Do not operate the tool if you are too tired.**
- **Never touch any moving parts of the tool when running.**

ABOUT WORK AREA

- **Keep the work area clean.**
Cluttered work areas (e.g. workbench) invite accidents.
- **Carefully select the work area.**
Do not expose tool to rain.
Do not use tool in a wet or soaked area.
See that the work area is adequately illuminated.
- **Never work near inflammable liquid or in a potentially explosive atmosphere.**
- **Keep children away from the work area.**
Keep children and unauthorized people away from the work area to avoid accident or injury.

BEFORE OPERATION

- **Inspect tool before use.**
Before using, check that screws are securely tightened, that any protective cover or guard is securely in place, other parts are free from damage and that the tool runs as it should.
Check that moving parts are properly adjusted for positioning and tightened, that parts are free from damage and properly mounted, and that all other parts are in good condition for normal operation.
Should you find any damage to the protective cover or other part, replace it in accordance with the Operation Manual. If there are no instructions in the Manual, please contact the sales agent through which you have purchased your tool or an authorized dealer near you for repair.
Likewise, if a switch failure occurs, contact sales agent through which you have purchased your tool or an authorized dealer near you for repair. .
Do not use the tool if it does not start or stop with the start/stop switch.
- **Securely mount cutter**
An improperly mounted cutter may fly out, causing possible damage to the tool or injury to the operator.
- **Always remove spanner, wrench, etc., once adjustment has been made with them.**
- **Use a tool appropriate for the application.**
Avoid heavy-duty application that is beyond the capacity of tool.
- **Do not use the tool for purposes other than what it is designed for.**
- **Do not abuse tool.**
Use tool in accordance with the specifications: you'll get the most out of it while ensuring safety.
- **Securely fasten workpiece in place.**
Use a vice or clamp to securely fasten the workpiece in place. It is much safer this way than holding it in your hand, allowing you to operate the tool with both hands.

ABOUT HANDLING

- **How to store tool.**
When the tool is not used, store it in a dry area and out of reach of children.
- **How to carry tool.**
Do not touch the start switch while the tool is being carried.
- **Do not leave the tool unattended while it is running.**
Turn off the start switch and disconnect the tool from

power source. Do not leave the work area until the tool comes to a complete stop.

MAINTENANCE/SERVICE

- **Do not take apart or modify tool.**

Disassembly or modification carried out without the supervision of a qualified or authorized service engineer could result in an accident or injury.

- **Inspect cutting tool and accessories, etc.**

Always check to see that cutting tool and accessories, etc. are in good operating condition without damage or deterioration before you mount them on the tool. Should you find any damage to an accessory or part, please contact sales agent through which you have purchased your tool or an authorized dealer near you for repair.

- **Check parts for damage.**

When you have found damage to accessory or other part, carefully check the damaged part to determine the extent of influence it has upon the functions of the tool – that is, determine whether it can still perform its normal functions.

Check to see that the linkage of the moving parts is OK, that all parts are OK without damage, that they are properly mounted, and that the tool functions normally. Should you find any damage to an accessory or part that may hamper proper functioning of the tool, please contact sales agent through which you have purchased your tool or an authorized dealer near you for repair.

- **Have your tool repaired at an authorized Nitto Service Center.**

For repair or parts replacement, please contact the sales agent through which you have purchased your tool or an authorized dealer near you.

- **Use only Nitto genuine parts.**

Use of improper parts may result in serious accident. To obtain a Nitto genuine part, consult this Manual or contact the sales agent from which you have purchased your tool directly.

- **Do not detach label or nameplate from tool.**

When a label/nameplate gets damaged, worn or becomes missing, contact the sales agent through which you have purchased your tool or Nitto Kohki Co. Ltd, directly for a replacement.

DISPOSAL

- When a tool is taken permanently out of service, it is advised that the tool is disassembled, degreased and parts separated by material and recycled locally in the appropriate manner.

GENERAL: PNEUMATIC TOOLS

WARNING

- **Use appropriate air pressure.**

Excessively high air pressure will increase the tool number of revolutions or strokes causing not only potential premature failure/breakage but could also lead to an unexpected accident or injury.

- **Connect tool to air supply line.**

There are various types of pipes running in a factory in addition to the pneumatic line (such as oxygen, nitrogen, gas and water). For this reason, always ensure that you are connecting to the pneumatic line.

- **Start tool properly.**

Turn the start switch OFF before connecting to the air supply line.

- **Always disconnect the tool from the air supply line before putting on/taking off any accessory and prior to carrying out any maintenance work.**

- **Avoid exposure to exhaust air.**

Pneumatic tool exhaust air contains oil and contaminated moisture. Make sure the exhaust air is not directed towards your face or anyone else within the work area.

- **Keep tool off electricity.**

This pneumatic tool is not electrically insulated. To avoid a potential electric shock do not use where there is a possibility of coming into contact with live electricity.

CAUTION

- **Handle tool carefully.**

Abusive use of tool could invite failure or accident. Do not throw, drop or shock the tool.

- **Handle air hose carefully.**

Do not carry the tool by the air hose. Do not pull the air hose to disconnect.

INSTRUCTIONS FOR THIS TOOL

About Your Tool

WARNING

- Always turn off the air supply and supply hose beforehand whenever replacing Indexable Insert.
- To replace the Indexable Insert after using, do not touch with bare hands as the Indexable Insert and holder are heated at high temperature.
- Use our original Indexable Inserts.
- Do not use the worn or damaged Indexable Insert.

1. USAGE

This tool is for chamfering workpieces with a Indexable Insert.

2. CHECK THE CONTENTS OF THE PACKAGE

Check the contents and make sure that the tool does not have any damage which may have occurred during transportation. The contents should correspond to the list as follows. In case of damage/missing parts, please contact the sales agent from whom you purchased the tool.

Package Contents	Qty	Check
CIRCUIT BEVELER CB-02	1set	
Bushing R1/4xNPT1/4	1	
Indexable Insert with Hole 9.525	1	
Spanner T-9F	1	
Hook Spanner 58-62	1	
Protective Cap	1	
Gauge	1	
Instruction Manual	1	
Declaration of Conformity	1	
Caution for Use	1	

3. AIR SUPPLY

3-1. Air Pressure

Adjust air pressure with the air regulator to the appropriate level for the pneumatic tool used.

Air pressure that is too low will stop the tool from operating at full capacity.

Air pressure that is too high may cause damage to the tool.

3-2. Air Line (Fig.1)

Use a 9.5 mm (3/8") I. D. connecting hose between the compressor and the tool.

Drained water, etc., if flown into the tool, could cause tool failure. Install an air filter between the

compressor and the tool.

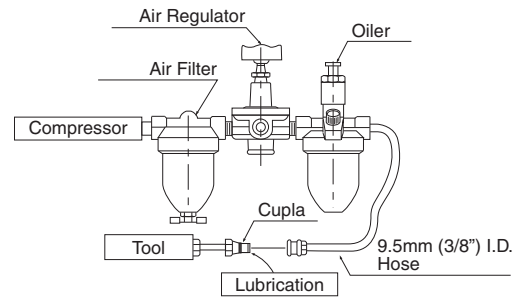

Fig.1

3-3. Lubrication

Install an oiler between the compressor and the tool. Use the machine oil ISO VG-10. Failure to lubricate as required may result in damage to the tool. Use of oil that is too thick will reduce the performance of the tool.

4. HOW TO OPERATE THE TOOL

4-1. Dimensions of material to be chamfered. (Fig.2, Fig.3)

Minimum chamfering dimensions are hole diameter 12mm, radius 6mm, and plate thickness 10mm. Also, chamfering of groove (Fig.3), minimum depth required is 20mm.

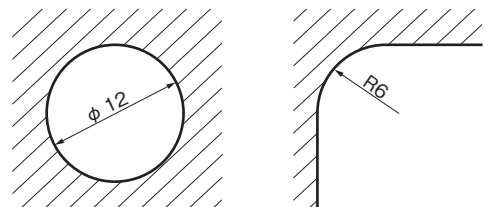

Fig.2

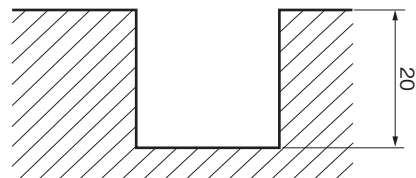

Fig.3

4-2. How to use

(1) Rotate the motor first and press the tool gently against the work piece as the Indexable Insert may result in damage.

Never start the motor with pressing the tool against the work piece.

(2) Cutting direction should be in the same direction as the motor rotation. (Fig.4)

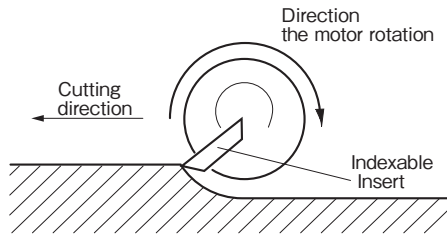

Fig.4

- (3) If the initial cut is such an edge as in Fig.5, before chamfering, grind the edge off.

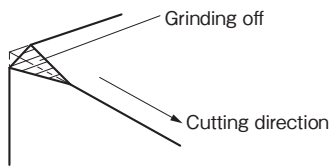

Fig.5

- (4) When chamfering, fix the work piece firmly. Especially, small parts must be held completely with a device such as a vice.

4-3. Start and Stop (Fig.6)

- (1) Remove the Protective Cap and adjust the chamfering size to fit your desired size using the Gauge of a standard accessory.
- (2) Check that a Throttle Lever is turned off and connecting the tool to the hose leading to air supply line.
- (3) Hold the tool, release the Lock Lever, and grasp the Throttle Lever to start.
- (4) When the Throttle Lever is released, it will automatically turn off.

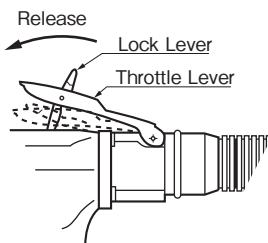

Fig.6

4-4. Operation

- (1) While rotating the motor, press the tool against the work piece. (Note a.)
- (2) While pressing the Guide Bearing (TQ00625) against the work piece, feed at the steady speed. (Note b.)

4-5. Adjusting method for chamfering amount. (Fig.7)

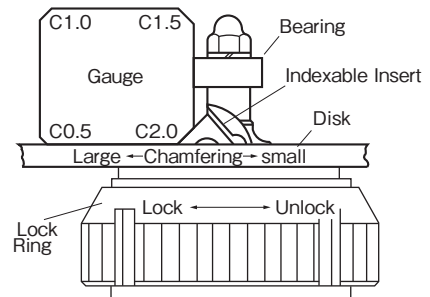

Fig.7

! WARNING

- When adjusting the chamfering size, disconnect the air hose.

! CAUTION

- If chamfering size is important, chamfer the test piece and check the amount of chamfering before actual on the work piece.

- (1) Loosen the Lock Ring.
- (2) Apply the Gauge to the Disk and the bearing, rotate the Disk up and down so that the end of the Indexable Insert touches the Gauge.
- (3) Tighten the Lock Ring with the Hook Spanner Wrench of a standard accessory.

4-6. About Radius Surface Chamfering

! WARNING

- Always turn off the air supply and disconnect the air supply hose.

This tool can do radius chamfering (2R). (Fig.8)
The Indexable Insert for 2R is available as an option.

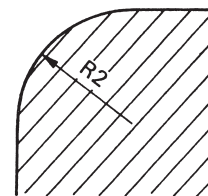

Fig.8

4-7. Adjustment of R surface chamfering and procedure. (Fig.9)

- (1) Install R tip (3-4).
- (2) As in Figure 9, adjust the height of the Disk to be aligned with the Indexable Insert. (Point A)
- (3) Do the test chamfering and check its finishing condition before starting the actual chamfering on the work piece.

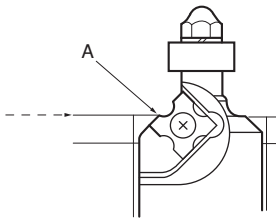

Fig.9

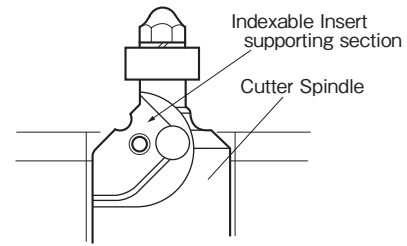

Fig.11

5. HOW TO REPLACE INDEXABLE INSERT

WARNING

Always turn off the air supply and disconnect the air supply hose.

(1) Timing of replacement. (Four sides of each tip can be used.)

A dull Indexable Insert may be dangerous as it may chip off or damage the tool mechanism by vibration. Therefore, it must be replaced with a new genuine Indexable Insert, when the following cases happen.

- a. Indexable Insert damaged.
- b. Sparks when chamfering.
- c. Chamfering surface became rough.
- d. Cutting ability worsened.

(2) Indexable Insert replacement method (Fig.10)

- a. Loosen the Lock Ring.
- b. Rotate and remove the Disk.
- c. Unfasten the Tip Setting Screw with the Spanner Wrench of a standard accessory.
- d. Install the new Indexable Insert making sure it is in the correct direction and tighten it with the Tip Setting Screw.
- e. Install the Disk, adjust the chamfering size to your desired length and tighten the Lock Ring.

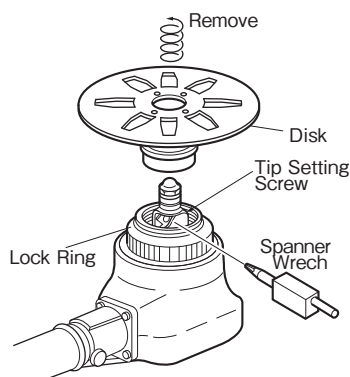

Fig.10

5-1. About The Cutter Spindle (Fig.11)

With prolonged use, the Indexable Insert supporting section will sag.

The sag will cause Indexable Insert damage. Therefore, the sagged Cutter Spindle should be replaced.

6. CONDITION FOR USE

Burn-out chips suggest that either the feed speed is too slow or the Indexable Insert has worn-out. Change the cutting conditions or check the conditions of the Indexable Insert.

7. THREAD SIZE OF HOSE FITTING

The product comes with a metal fitting with Rc (metric) thread. Connect the Bushing R thread x NPT thread included as standard accessories, if you would like to have American NPT thread instead.

8. STORAGE

CAUTION

When tool is not used, store it out of reach of children.

Avoid storing the tool in a location subject to high humidity. If the tool is left as it is used, residual moisture on the inside can cause rusting. Before storing, and after operation, oil the tool at the air inlet with machine oil ISO VG-10 and run it for a short time. In order to protect the Indexable Insert, place the Protective Cap on the Disk. Also, by placing the Gauge to the Protective Cap, you can prevent its loss. (Fig.12)

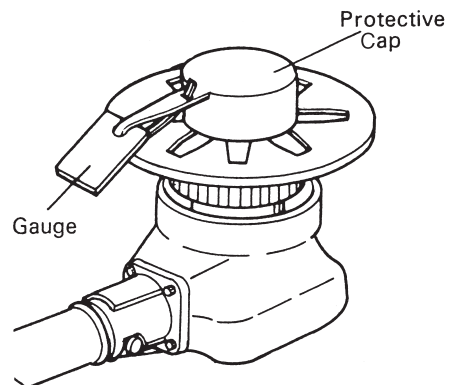

Fig.12

9. ORDERING SERVICE PARTS

- For further operational and handling information or for replacement of parts and components, contact the company from whom you purchased the tool or an authorized dealer.
- In ordering parts and components give each part number, description and quantity required.
- Use only NITTO genuine parts.

10. OPTIONAL PARTS

Part No.	Description	Qty
TA9A386	Indexable Insert with Hole 9.525	10 pcs
TA9A592	Indexable Insert 9.525 sq. R2	10 pcs
TA9A638	Indexable Insert 9.525 sq. R3	10 pcs

11 EXPLODED DIAGRAM : CB-02

WARNING

This diagram is for your reference only. Do not attempt to service or repair the Tool.

Do not take the Tool apart. Contact an authorized Nitto dealer for all service and repair of the Tool.

Improper service and repair can cause accidents and severe injuries.

Never attempt to modify the Tool.

Never attempt service or repair the Tool yourself.

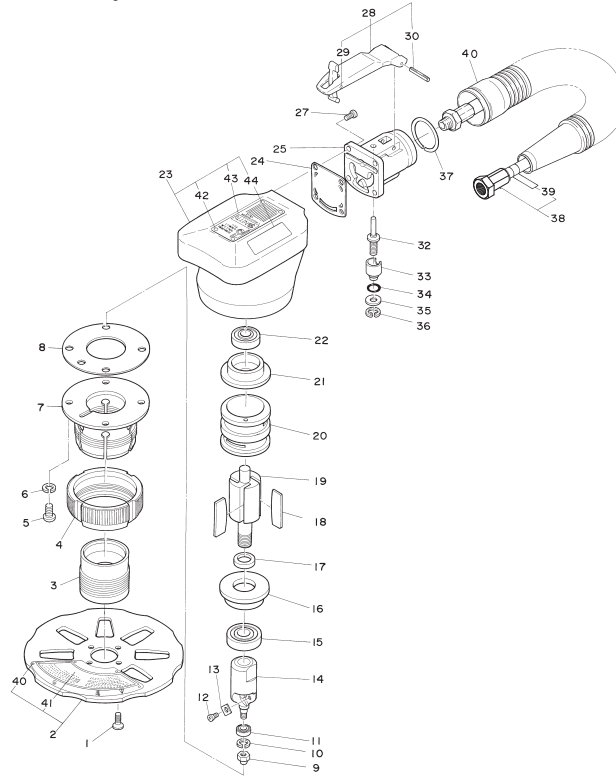

The parts numbers with () are included in the Ass'y parts written above them.

No.	Part No.	Description	Qty	Price
1	TP00112	Cross Recessed Countersunk Head Screw 4x10	4	
2	TB00668	Disk Sub Ass'y	1set	
40	(TP17131)	Drive Screw 2x3.2	4	
41	(TQ00851)	Warning Plate	1	
3	TQ00629	Adjuster	1	
4	TQ00632	Lock Ring	1	
5	TP00511	Cross Recessed Pan Head Screw 5x15	4	
6	TP00513	Spring Washer M5	4	
7	TQ00631	Housing Connector	1	
8	TQ00633	Packing	1	
9	TQ00627	Hex. Cap Nut M4	1	
10	TP04234	Spring Washer M4	1	
11	TQ00625	Ball Bearing L1150ZZ	1	
12	TQ00626	Tip Setting Screw	1	
13	TP9A386	Indexable Insert with Hole 9.525 (10 pcs./set)	1set	
14	TQ00624	Cutter Spindle	1	
15	TP01913	Ball Bearing 6000ZZ	1	
16	TP01911	End Plate B	1	
17	TP01912	Distance Collar	1	
18	TA9A212	Blade Ass'y (4 pcs.)	1set	
19	TQ00623	Rotor	1	
20	TP10000	Cylinder	1	
21	TP01907	End Plate A	1	
22	TP00468	Ball Bearing 608ZZ	1	
23	TB08734	Housing Ass'y	1set	
42	(TP00078)	Drive Screw 1.85x3.2	4	

No.	Part No.	Description	Qty	Price
43	(TQ12792)	Name Plate	1	
44	(TQ12611)	Warning Label CE Mark	1	
24	TP16050	Packing A	1	
25	TP16047	Valve Body	1	
27	TP02638	Cross Recessed Pan Head Screw 4x12	4	
28	TB01152	Throttle Lever Ass'y	1set	
29	(TP05498)	Spring Pin 2x16 AW	1	
30	(TP00460)	Spring Pin 3x22 AW	1	
32	TA93070	Valve Stem Assy	1set	
33	TP06325	Adjust Valve	1	
34	TP11997	O Ring KS-7	1	
35	TP06326	Spacer 6x12x1.2	1	
36	TP03695	Retaining Ring C-12	1	
37	TP09153	Stop ring 0-28.5x2	1	
38	TB07658	Air Hose C Ass'y	1set	
39	(TQ11519)	Label Lubrication	1	
40	TQ01664	Exhaust Hose	1	

Accessories

No.	Part No.	Description	Qty
	TP02236	Bushing R1/4xNPT1/4	1
		Indexable Insert with Hole 9.525	1
	TP16980	Spanner T-9F	1
	TQ00636	Hook Spanner 58-62	1
	TQ00637	Protective Cap	1
	TQ00638	Gauge	1
	TQ12793	Instruction Manual	1
	TQ12785	Declaration of Conformity	1



Overseas Affiliates / Offices

NITTO KOHKI U.S.A ., Inc.
4525 Turnberry Drive, Hanover Park, IL 60133, U.S.A
Tel: (1)-630-924-9323 Fax: (1)-630-924-0303
<http://www.nittokohki.com/index.html>

NITTO KOHKI EUROPE Co., Ltd.
Unit 21, Empire Centre, Imperial Way,
Watford Hertfordshire, WD24 4TS, United Kingdom
Tel: (44)-01923-239668 Fax: (44)-01923-248815
<http://www.nitto.co.uk/>

NITTO KOHKI DEUTSCHLAND GmbH
Lerchenstr. 47, D-71144 Steinenbronn, Germany
Tel: (49)-7157-22436 Fax: (49)-7157-22437
<http://www.nitto-kohki.de/>

NITTO KOHKI AUSTRALIA Pty. Ltd.
77 Brandl Street, Eight Mile Plains QLD 4113,
Australia
Tel: (61)-7-3340-4600 Fax: (61)-7-3340-4640
<http://www.nitto-australia.com.au/>

NITTO KOHKI Co., Ltd. Singapore Branch
10 Ubi Crescent #01-62, Ubi Techpark Lobby D,
Singapore 408564

Tel: (65)-6227-5360 Fax: (65)-6227-0192
<http://www.nitto-kohki.co.jp/e/nksb/>

NITTO KOHKI Co., Ltd. Shanghai Representative Office
#1117 Ruijing Building, Maoming South Road,
Shanghai 200020 China

Tel: (86)-21-6415-3935 Fax: (86)-21-6472-6957
<http://www.nitto-kohki.cn/>

NITTO KOHKI Co., Ltd. Shenzhen Representative Office
#0726 International Culture Building, 3039, Shennan
Zhong Rd., Futian District, Shenzhen, 518003 China

Tel: (86)-755-8375-2185 Fax: (86)-755-8375-2187
<http://www.nitto-kohki.cn/>

NITTO KOHKI Co., Ltd. Bangkok Representative Office
38Q, House Convent Bldg, 7th Floor, Unit 7A,
Convent Rd, Silom, Bangkok, 10500 Thailand

Tel: (66)-2-632-0307 Fax: (66)-2-632-0308
http://www.nittobkk.com/eng_index.htm

EC DECLARATION OF CONFORMITY

We hereby declare that the following our product conforms with the essential health and safety requirements of EEC Directives.

Product: PNEUMATIC CHAMFERING TOOL
Model: CIRCUIT BEVELER : CB-02
Serial No: X X X X X X
└──┬───────────▶ Consecutive numbers (00001~99999)
 └──▶ Christian era's last digit (0~9)
Manufacturer: NITTO KOHKI Co., Ltd.
2-9-4, Nakaikegami, Ohta-ku, Tokyo, 146-8555, Japan
Authorised Compiler in the Community:
Masatoshi Ogue
President
NITTO KOHKI EUROPE Co., Ltd.
Unit 21, Empire Centre, Imperial Way, Watford Hertfordshire, WD24 4TS, UK
Tel: (44)-01923-239668 Fax: (44)-01923-248815
Directive: 98/37/EC and 2006/42/EC Machinery Directive

The above product has been evaluated for conformity with above directives using the following European standards.
The technical construction file (TCF) for this product is retained at the above manufacturer's location.

Machinery Directive: EN ISO12100-1:2003, EN ISO12100-2:2003,
EN ISO14121-1:2007, EN792-11:2000+A1:2008, others
Sound Pressure/Power Level: EN ISO15744:2008, EN ISO4871:1996
Vibration Level: EN28662-1:1992, EN ISO8662-10:1998

Name: K.Kishi
Title: GENERAL MANAGER MACHINE TOOLS DIV.

Being the responsible person appointed and employed the manufacturer.