

INSTRUCTION MANUAL

PNEUMATIC HAND DRILL

Please read this manual carefully before you attempt to use your tool so that you may use it properly and safely.

AIR DRILL Model ADR-65 ADR-100 **PROFESSIONAL TOOL**



Specifications

Model	ADR-65	ADR-100
Maximum Operating Pressure	0.6 MPa	
Air Consumption (No Load)	0.55 m ³ /min	0.67 m ³ /min
Stroke Speed (No Load)	2900 r/min(min ⁻¹)	2000 r/min(min ⁻¹)
Sound Pressure Level	76 dB(A)	77 dB(A)
Sound Power Level	87 dB(A)	88 dB(A)
Vibration Level [Uncertainty K]	4.9 m/s ² [2.9 m/s ²]	2.5 m/s ² [0.75 m/s ²]
Max. Chuck Size	6.5 mm	10.0 mm
Mass (Weight)	0.8 kg	1.1 kg

Due to continuous product development/improvement the specifications and configurations in this document are subject to change without prior notice.



Manufactured by :

NITTO KOHKI Co., Ltd.

2-9-4, Nakaikegami, Ohta-ku,
Tokyo, 146-8555, Japan

Tel : (81)-3-3755-1111

Fax : (81)-3-3753-8791

E-mail : overseas@nitto-kohki.co.jp

URL : www.nitto-kohki.co.jp

Keep the manual handy – so you can use it whenever necessary.

Original Instructions

Thank you very much for your purchase of this **Nitto Kohki products**.

Before using your tool, please read this manual carefully so that you may use it properly to get the most out of it.

Please keep the manual handy - so you can use it whenever necessary.

- **English** : Please ask your dealer or distributor for instruction manual in local language(s).
- **German** : Bitte fragen Sie Ihren Händler nach eine Betriebsanleitung in Landessprache.
- **French** : S'il vous plait, veuillez demandez á votre fournisseur de manuel instruction en langue locale.
- **Spanish** : Por favor, contacte con su distribuidor para el manual de instrucciones en español.
- **Portuguese** : Por favor pessa ao seo agente ou distribuidor o manual de instrucces ih linguagen local.
- **Italian** : Per Manuale Istruzioni in lingua locale Vi preghiamo di rivolgervi al rivenditore o distributore.
- **Dutch** : Vraag uw handelaar om een nederladstalige gebruiksaanwijzing.
- **Swedish** : Be er lokala Åtreförsäljare eller distributör om manualer pá svenska.
- **Danish** : Venligst henvend Dem til den danske distributør for instructions manualer.
- **Polish** : Proszę pytać swojego dealera lub dystrybutora o instrukcje obsługi w języku localnym.
- **中文** : 請向當地供應商或經銷商詢問中文使用說明書

CONTENTS	page
IMPORTANT SAFETY INSTRUCTIONS	2
GENERAL: TOOLS	2
GENERAL: PNEUMATIC TOOLS	3
INSTRUCTIONS FOR THIS TOOL	4
1. USAGE	4
2. CHECK THE CONTENTS OF THE PACKAGE	4
3. AIR SUPPLY	4
4. HOW TO OPERATE THE TOOL	5
5. THEREAD SIZE OF HOSE FITTING	5
6. STORAGE	6
7. ORDERING SERVICE PARTS	6
8. OPTIONAL PARTS	6
9. EXPLODED DIAGRAM : ADR-65	7
10. EXPLODED DIAGRAM : ADR-100	8

PICTOGRAM



Warning: It might be dangerous to operate the tool if the instructions supplied are not followed.



Using this tool improperly could result in serious injury. Read the instruction manual before using.



Always wear suitable eye protection.



Always wear suitable hearing protection.



Always wear respiratory protective equipment (PPE).

The following Safety notations are used throughout the manual to highlight safety precautions for the user and for the tool.



WARNING:

Indicates a potentially hazardous situation which, if not avoided by following the instructions given, could result in death or serious injury.



CAUTION:

Indicates a potentially hazardous situation which, if not avoided by following the instructions given, could result in injury or material damage.

Please note, however, that failure to observe safety precautions under the “**Caution**” category could result in a serious occurrence depending on the situation: please observe all safety precautions in the manual.

Caution: Important precautions for tool setup, operation and maintenance.

IMPORTANT SAFETY INSTRUCTIONS

When using the tool, please observe the safety precautions below to prevent possible accident or injury.

GENERAL: TOOLS

WARNING

TO OPERATORS

- **Wear proper clothing for the type of work being done.**

Take care to avoid entanglement with the moving parts of the tool with clothing, ties, hair etc. If items become entangled it will cause the operator to be pulled towards the tool and lead to possible cause of accident or injury.

- **Always wear suitable eye protection.**

Remember, regular glasses are not safety glasses. The lenses are only shock resistant, which will not give you sufficient eye protection you may need in your working environment.

- **Always wear suitable hearing protection.**

- **Wear respiratory protective equipment (PPE).**

Wear respiratory protective equipment (PPE) when working in an environment where dust particles are generated in operation.

- **Avoid working posture that is too stressful.**

Always ensure a firm footing and well balanced posture.

- **Do not operate the tool if you are too tired.**

- **Never touch any moving parts of the tool when running.**

ABOUT WORK AREA

- **Keep the work area clean.**

Cluttered work areas (e.g. workbench) invite accidents.

- **Carefully select the work area.**

Do not expose tool to rain.

Do not use tool in a wet or soaked area.

See that the work area is adequately illuminated.

- **Never work near inflammable liquid or in a potentially explosive atmosphere.**

- **Keep children away from the work area.**

Keep children and unauthorized people away from the work area to avoid accident or injury.

BEFORE OPERATION

- **Inspect tool before use.**

Before using, check that screws are securely tightened, that any protective cover or guard is securely in place, other parts are free from damage and that the tool runs as it should.

Check that moving parts are properly adjusted for positioning and tightened, that parts are free from damage and properly mounted, and that all other parts are in good condition for normal operation.

Should you find any damage to the protective cover or other part, replace it in accordance with the Operation Manual. If there are no instructions in the Manual, please contact the sales agent through which you have purchased your tool or an authorized dealer near you for repair.

Likewise, if a switch failure occurs, contact sales agent through which you have purchased your tool or an authorized dealer near you for repair.

Do not use the tool if it does not start or stop with the start/stop switch.

- **Securely mount cutter.**

An improperly mounted cutter may fly out, causing possible damage to the tool or injury to the operator.

- **Always remove spanner, wrench, etc., once adjustment has been made with them.**

- **Use a tool appropriate for the application.**

Avoid heavy-duty application that is beyond the capacity of tool.

- **Do not use the tool for purposes other than what it is designed for.**

- **Do not abuse tool.**

Use tool in accordance with the specifications: you'll get the most out of it while ensuring safety.

- **Securely fasten workpiece in place.**

Use a vice or clamp to securely fasten the workpiece in place. It is much safer this way than holding it in your hand, allowing you to operate the tool with both hands.

ABOUT HANDLING

- **How to store tool.**

When the tool is not used, store it in a dry area and out of reach of children.

- **How to carry tool.**

Do not touch the start switch while the tool is being carried.

- **Do not leave the tool unattended while it is running.**

Turn off the start switch and disconnect the tool from power source. Do not leave the work area until the tool comes to a complete stop.

MAINTENANCE/SERVICE

- **Do not take apart or modify tool.**

Disassembly or modification carried out without the supervision of a qualified or authorized service engineer could result in an accident or injury.

- **Inspect cutting tool and accessories, etc.**

Always check to see that cutting tool and accessories, etc. are in good operating condition without damage or deterioration before you mount them on the tool. Should you find any damage to an accessory or part, please contact sales agent through which you have purchased your tool or an authorized dealer near you for repair.

- **Check parts for damage.**

When you have found damage to accessory or other part, carefully check the damaged part to determine the extent of influence it has upon the functions of the tool – that is, determine whether it can still perform its normal functions.

Check to see that the linkage of the moving parts is OK, that all parts are OK without damage, that they are properly mounted, and that the tool functions normally. Should you find any damage to an accessory or part that may hamper proper functioning of the tool, please contact sales agent through which you have purchased your tool or an authorized dealer near you for repair.

- **Have your tool repaired at an authorized Nitto Service Center.**

For repair or parts replacement, please contact the sales agent through which you have purchased your tool or an authorized dealer near you.

- **Use only Nitto genuine parts.**

Use of improper parts may result in serious occurrence.

To obtain a Nitto genuine part, consult this Manual or contact the sales agent from which you have purchased your tool directly.

- **Do not detach label or nameplate from tool.**

When a label/nameplate gets damaged, worn or becomes missing, contact the sales agent through which you have purchased your tool or Nitto Kohki Co. Ltd, directly for a replacement.

DISPOSAL

- When a tool is taken permanently out of service, it is advised that the tool is disassembled, degreased and parts separated by material and recycled locally in the appropriate manner.

GENERAL:PNEUMATIC TOOLS

WARNING

- **Use appropriate air pressure.**

Excessively high air pressure will increase the tool number of revolutions or strokes causing not only potential premature failure/breakage but could also lead to an unexpected accident or injury.

- **Connect tool to air supply line.**

There are various types of pipes running in a factory in addition to the pneumatic line (such as oxygen, nitrogen, gas and water). For this reason, always ensure that you are connecting to the pneumatic line.

- **Start tool properly.**

Turn the start switch OFF before connecting to the air supply line.

- **Always disconnect the tool from the air supply line before putting on/taking off any accessory and prior to carrying out any maintenance work.**

- **Avoid exposure to exhaust air.**

Pneumatic tool exhaust air contains oil and contaminated moisture. Make sure the exhaust air is not directed towards your face or anyone else within the work area.

- **Keep tool off electricity.**

This pneumatic tool is not electrically insulated. To avoid a potential electric shock do not use where there is a possibility of coming into contact with live electricity.

CAUTION

- **Handle tool carefully.**

Abusive use of tool could invite failure or accident. Do not throw, drop or shock the tool.

- **Handle air hose carefully.**

Do not carry the tool by the air hose. Do not pull the air hose to disconnect.

INSTRUCTIONS FOR THIS TOOL

About Your Tool

WARNING

- **Wear protective glasses and a dustproof mask.**
Operation generates chips and dust particles, etc. which may cause eye and/or respiratory injury: Always use PPE (Personal Protective Equipment) for eye and respiratory protection.
- **Always wear suitable hearing protection.**
The tool generates loud noise. Always use ear plugs for hearing protection. Take necessary measures to comply with the local regulatory requirements and laws with regard to noise level, or do better.
- **When the drill passes through or locked during drilling or tapping, the main body may be swung around. If it occurs, release the Trigger quickly to avoid injury.**
- **Do not tap a blind hole using this air drill.**
- **Never touch moving parts.**

CAUTION

- **For tapping, always use tapping paste.**
- **Use sharp taps.**
- **Use a taper tap (No.1) and a plug tap (No.2) for tapping.**

1. USAGE

This tool is for drilling work with a drill bit. Tapping (right-hand screw) is also possible by using the reversible function.

2. CHECK THE CONTENTS OF THE PACKAGE

Check the contents and make sure that the tool does not have any damage which may have occurred during transportation. The contents should correspond to the list as follows. In case of damage/missing parts, please contact the sales agent from whom you purchased the tool.

ADR-65

Package Contents	Qty	Check
ADR-65	1	
30SH	1	
Chuck Handle	1	
Bushing R1/4xNPT1/4	1	
Instruction Manual	1	
Declaration of Conformity	1	
Caution for Use	1	

ADR-100

Package Contents	Qty	Check
ADR-100	1	
30SH	1	
Chuck Handle	1	
Bushing R1/4xNPT1/4	1	
Instruction Manual	1	
Declaration of Conformity	1	
Caution for Use	1	

3. AIR SUPPLY

3-1. Air Pressure

Adjust air pressure with the air regulator to the level appropriate for the pneumatic tool used.

Air pressure that is too low will fail the tool to operate at full capacity

Air pressure that is too high may cause damage to the tool.

3-2. Air Line (Fig.1)

Use a 9.5mm (3/8") I.D. connecting hose between the compressor and the tool.

Drained water, etc., if flown into the tool, could cause tool failure. Install an air filter, between the compressor and the tool.

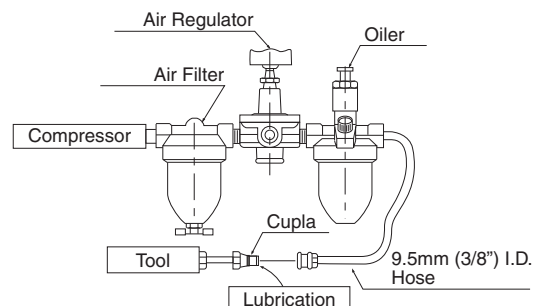

Fig. 1

3-3. Lubrication

Install an oiler between the compressor and the tool. Use the machine oil ISO VG-10. Failure to lubricate as required may result in damage to the tool. Use of oil that is too thick will reduce the performance of the tool.

4. HOW TO OPERATE THE TOOL

WARNING

Turn off the air supply and disconnect the air hose before replacing the Drill Bit.

4-1. How to Hold the Air Drill (Fig.2)

For Stable operation, hold the grip of the Air Drill by one hand with the middle finger put on the Trigger and the index finger extended over the main body, and grip the main body firmly with the other hand as below figure.

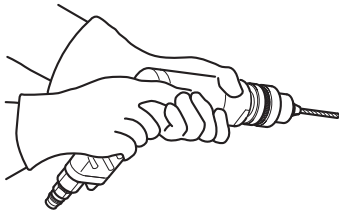

Fig. 2

4-2. How to Adjust Rotating Speed (Fig.3)

Turn the Speed Control Nut to adjust the drill rotating Speed. Adjust the rotating speed for the operation requirement.

4-3. How to Change Rotation Direction (Fig.3)

Change rotation direction by turning the valve as indicated.

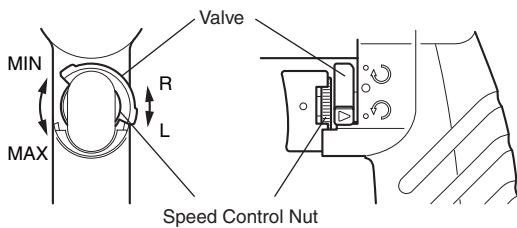

Fig. 3

4-4. Mounting the Drill Bit (Fig.4)

Mount the drill bit to the Chuck, and tighten the Chuck securely with the accessory Chuck Handle.

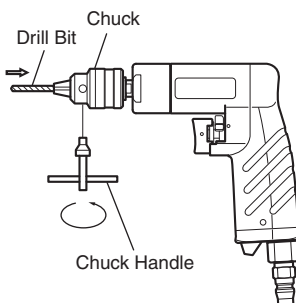

Fig. 4

4-5. Start and Stop (Fig.5)

- (1) Confirm that the Trigger is OFF and fit the connecting hose onto the Cupla plug on the Air Drill.
- (2) To turn on the Air Drill, hold the Air Drill by hands and pull the Trigger.
- (3) To turn it off, release the Trigger.

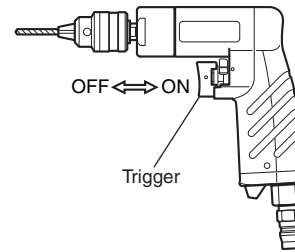

Fig. 5

4-6. Tapping Operation

CAUTION

- Make sure the hole as large as possible within the tolerance for strength.

- (1) Drill a hole before tapping.
- (2) Apply tapping paste to the tap.
- (3) Confirm that the Valve is set for normal rotation direction. (Fig.5)
- (4) Align the tap with the hole, and start tapping. If the top end of drill cannot break into the hole when the tap diameter is large, manually rotate the drill in normal rotating direction by several turns with the Trigger set on, and then start tapping.
- (5) After tapping ends, change the rotation direction, and pull out the tap while the drill is rotating reversely.

5. THREAD SIDE OF HOSE FITTING

The product comes with a metal-fitting with R thread. Connect the Bushing R thread X NPT thread included as standard accessories. If you would like to have American NPT thread instead.

6. STORAGE

CAUTION

When tool is not used, store it out of reach of children.

Avoid storing the tool in a location subject to high humidity, if the tool is left as it is used, residual moisture on the inside can cause rusting. Before storing, and after operation, oil the tool at the air inlet with machine oil ISO VG-10 and run it for a short time.

7. ORDERING SERVICE PARTS

For further operational and handling information or for replacement of parts and components, contact the company from whom you purchased the tool or an authorized dealer.

In ordering parts and components give each part number, part name and quantity required.

Use only NITTO genuine parts.

8. OPTIONAL PARTS

A hanger to be mounted on the bottom of the grip is available as option. It can be mounted on both ADR-65 and ADR-100.

Part No.	Description
TQ10969	Hanger

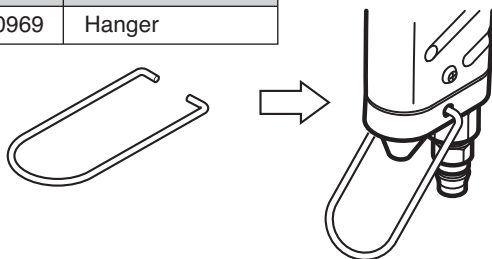
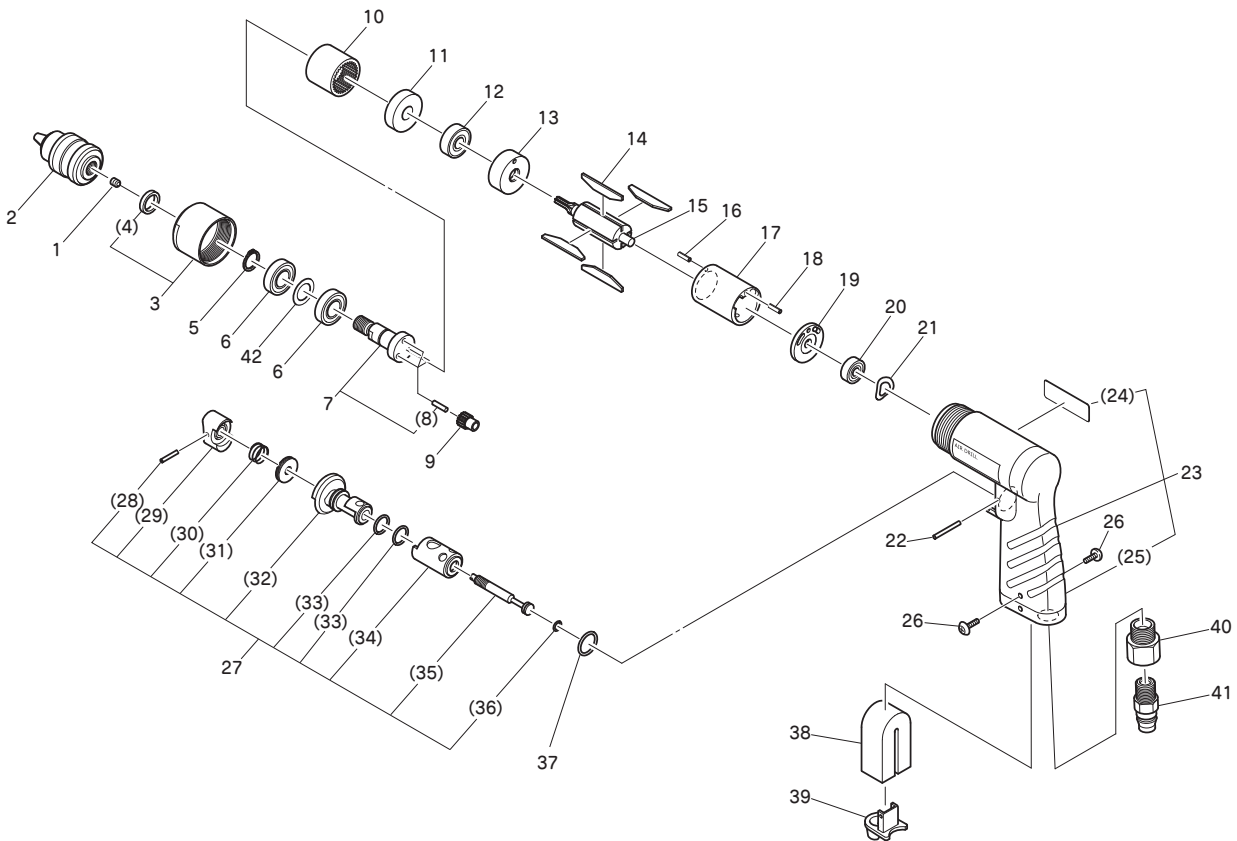

Fig. 6

9. EXPLODED DIAGRAM: ADR-65

WARNING

This diagram is for your reference only. Do not attempt to service or repair the Tool.
Do not take the Tool apart. Contact an authorized Nitto dealer for all service and repair of the Tool.
Improper service and repair can cause accidents and service injuries.
Never attempt to modify the Tool.
Never attempt service or repair the Tool yourself.



The part numbers with () are included in the Ass'y parts written above them.

No.	Part No.	Description	Qty	Price
1	TQ10993	Hex.Socket Head Setscrew 3/8-24UNF	1	
2	TQ10904	Drill Chuck 6.5mm (1/4")	1	
3	TB07329	Gear Case Cover Ass'y	1set	
4	(TP05506)	Oil Seal	1	
5	TP03546	External Retaining Ring C-12	1	
6	TQ10914	Ball Bearing 6901ZZ	2	
7	TB07331	Spindle Sub Ass'y	1set	
8	(TP05504)	Needle Roller 3 × 15.8	3	
9	TB07332	Planetary Gear Ass'y	3set	
10	TQ10895	Ring Gear	1	
11	TQ10905	Spacer	1	
12	TP00468	Ball Bearing 608ZZ	1	
13	TQ10900	End Plate B	1	
14	TA9A287	Blade Ass'y (4pcs/set)	1set	
15	TQ10898	Rotor	1	
16	TP00496	Spring Pin 2.5 × 6	1	
17	TQ10897	Cylinder	1	
18	TP12435	Spring Pin 2.5 × 10	1	
19	TQ10899	End Plate A	1	
20	TP03933	Ball Bearing 606ZZ	1	
21	TP06117	Waved Washer 12 × 16 × 0.3	1	
22	TP13548	Spring Pin 2.5 × 22	1	
23	TB08753	Housing Ass'y	1set	
24	(TQ12827)	Label Warning ADR-65	1	
25	(TQ10903)	Grip Rubber	1	

No.	Part No.	Description	Qty	Price
26	TQ10975	Binding Head Tapping Screw 3 × 6	2	
27	TB07321	Valve Ass'y	1set	
28	(TP07950)	Spring Pin 2 × 14	1	
29	(TQ10873)	Trigger	1	
30	(TQ10871)	Valve Spring	1	
31	(TQ10872)	Speed Control Nut	1	
32	(TQ10874)	Valve	1	
33	(CP24969)	O-Ring JASO-1011	1	
34	(TQ10875)	Valve Bushing	1	
35	(TQ10870)	Valve Stem	1	
36	(TP08994)	O-Ring P-5	1	
37	TQ10967	O-Ring S-16	1	
38	TB07385	Muffler Ass'y	1	
39	TQ10974	Exhaust Cover	1	
40	TP00857	Bushing M16 × Rc1/4	1	
41	CP00881	20PM	1	
42	TQ10999	Shim 0.1	1	

ACCESSORIES

No.	Part No.	Description	Qty	Price
	CA94930	30SH	1set	
	TQ10908	Chuck Handle	1	
	TQ12825	Instruction Manual	1	
	TQ12826	Declaration of Conformity	1	

10. EXPLODED DIAGRAM: ADR-100

⚠ WARNING

This diagram is for your reference only. Do not attempt to service or repair the Tool.
Do not take the Tool apart. Contact an authorized Nitto dealer for all service and repair of the Tool.
Improper service and repair can cause accidents and service injuries.
Never attempt to modify the Tool.
Never attempt service or repair the Tool yourself.

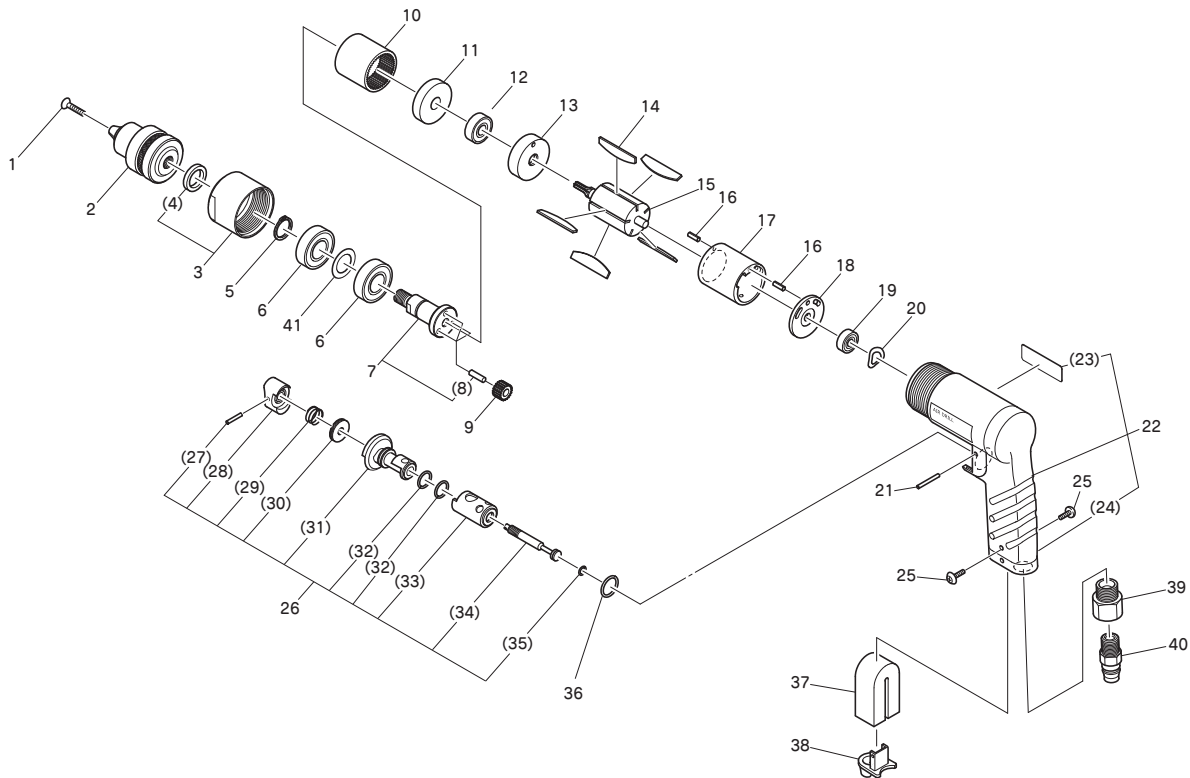

The part numbers with () are included in the Ass'y parts written above them.

No.	Part No.	Description	Qty	Price
1	TQ10880	Countersunk Head Screw 4×15	1	
2	TQ10879	Drill Chuck 10mm (3/8")	1	
3	TB07316	Gear Case Cover Ass'y	1set	
4	(TP05530)	Oil Seal	1	
5	TQ10861	External Retaining Ring C-15	1	
6	TP00539	Ball Bearing 6002ZZ	2	
7	TB07318	Spindle Sub Ass'y	1set	
8	(TQ10859)	Needle Roller 4×13.8	3	
9	TB07319	Planetary Gear Ass'y	3set	
10	TQ10860	Ring Gear	1	
11	TQ10881	Spacer	1	
12	TP00468	Ball Bearing 608ZZ	1	
13	TQ10869	End Plate B	1	
14	TB07380	Blade Ass'y (4pcs/set)	1set	
15	TQ10866	Rotor	1	
16	TP14798	Spring Pin 2.5×6	1	
17	TQ10865	Cylinder	1	
18	TQ10867	End Plate A	1	
19	TP03933	Ball Bearing 606ZZ	1	
20	TP06117	Waved Washer 12×16×0.3	1	
21	TP13548	Spring Pin 2.5×22	1	
22	TB07395	Housing Ass'y	1set	
23	(TQ12824)	Label Warning ADR-100	1	
24	(TQ10878)	Grip Rubber	1	
25	TQ10975	Binding Head Tapping Screw 3×6	2	

No.	Part No.	Description	Qty	Price
26	TB07321	Valve Ass'y	1set	
27	(TP07950)	Spring Pin 2×14	1	
28	(TQ10873)	Trigger	1	
29	(TQ10871)	Valve Spring	1	
30	(TQ10872)	Speed Control Nut	1	
31	(TQ10874)	Valve	1	
32	(CP24969)	O-Ring JASO-1011	1	
33	(TQ10875)	Valve Bushing	1	
34	(TQ10870)	Valve Stem	1	
35	(TP08994)	O-Ring P-5	1	
36	TQ10967	O-Ring S-16	1	
37	TB07385	Muffler Ass'y	1	
38	TQ10974	Exhaust Cover	1	
39	TP00857	Bushing M16×Rc1/4	1	
40	CP00881	20PM	1	
41	TQ10998	Shim 0.1	1	

ACCESSORIES

No.	Part No.	Description	Qty	Price
	CA94930	30SH	1	
	TQ10890	Chuck Handle	1	
	TQ12825	Instruction Manual	1	
	TQ12826	Declaration of Conformity	1	



Overseas Affiliates / Offices

NITTO KOHKI U.S.A., INC.

46 Chancellor Drive, Roselle, IL 60172 U.S.A.

Tel:(1)-630-924-9393 Fax:(1)-630-924-0303

NITTO KOHKI EUROPE CO., LTD.

Unit 21, The Empire Centre Imperial Way, Watford Herts, WD24 4TS, U.K.

Tel:(44)-1-923-239668 Fax:(44)-1-923-248815

NITTO KOHKI DEUTSCHLAND GMBH

Lerchenstr.47 D-71144 Steinenbronn, Germany

Tel:(49)-7-157-22436 Fax:(49)-7-157-22437

NITTO KOHKI CO., LTD., SINGAPORE BRANCH

10 UBI CRESCENT #01-62, UBI TECHPARK LOBBY D, SINGAPORE 408564,

Tel:(65)-6227-5360 Fax:(65)-6227-0192

NITTO KOHKI AUSTRALIA PTY. LTD.

77 Brandl St., Brisbane Technology Park, Eight Mile Plains QLD 4113 Australia

Tel:(61)-7-3340-4600 Fax:(61)-7-3340-4640

NITTO KOHKI CO., LTD.,

BANGKOK REPRESENTATIVE OFFICE

M&A Business Center 38Q. House Convent Bldg., 7th Floor, Unit 7A, Convent Rd., Silom, Bangrak, Bangkok 10500 Thailand

Tel:(66)-2-632-0307 Fax:(66)-2-632-0308

NITTO KOHKI (SHANGHAI) CO., LTD.

Room1506, suite C, Orient International Plaza, NO85 LouShanGuan Road, Shanghai, 200336, CHINA

Tel:(86)-21-6415-3935 Fax:(86)-21-6472-6957

NITTO KOHKI CO., LTD.,

SHENZHEN REPRESENTATIVE OFFICE

2005C Shenzhen ICC Tower, Fuhuasanlu 168, Futian District, Shenzhen, Guangdong, 518048 China

Tel:(86)-755-8375-2185 Fax:(86)-755-8375-2187



NITTO KOHKI Co., Ltd. 2-9-4, Nakaikegami, Ohta-ku, Tokyo, 146-8555, Japan Tel: (81)-3-3755-1111 Fax (81)-3-3753-8791

EC DECLARATION OF CONFORMITY

We hereby declare that the following our product conforms with the essential health and safety requirements of EU Directives.

Product: PNEUMATIC HAND DRILL
Model: AIR DRILL:ADR-100, ADR-65
Serial No: In the case of 6 digits serial number.
XXXXXXXX
Consecutive numbers (00001~99999)
Last digit (0-9) of year (A.D.)
In the case of 7 digits serial number.
XXXXXXXXX
Consecutive numbers (00001~99999)
Last two digits (00-99) of year (A.D.)

Manufacturer: NITTO KOHKI Co., Ltd. 2-9-4, Nakaikegami, Ohta-ku, Tokyo, 146-8555, Japan

Authorised person to prepare the technical construction file(TCF) in the community:

Masatoshi Ogue
President

NITTO KOHKI EUROPE Co., Ltd.
Unit21, Empire Centre, Imperial Way, Watford Hertfordshire,
WD24 4TS, UK
Tel:(44)-01923-239668 Fax:(44)-01923-248815

Directive: 2006/42/EC Machinery Directive

The above product has been evaluated for conformity with above directives using the following European standards. The technical construction file (TCF) for this product is retained at the above manufacturer's location.

Machinery Directive: EN ISO12100:2010, EN ISO11148-3:2012, others
Sound Pressure/Power Level: EN ISO15744:2008, EN ISO4871:1996
Vibration Level: EN28927-5:2009

Signature: K.Kishi

Date/Place: Feb. 18. 2010 Tokyo, Japan

Name: K.Kishi

Title: GENERAL MANAGER MACHINE TOOLS DIV.

NITTO KOHKI Co., Ltd.
2-9-4, Nakaikegami, Ohta-ku, Tokyo, 146-8555, Japan

Being the responsible person appointed and employed the manufacturer.